

The roller coaster comes down.

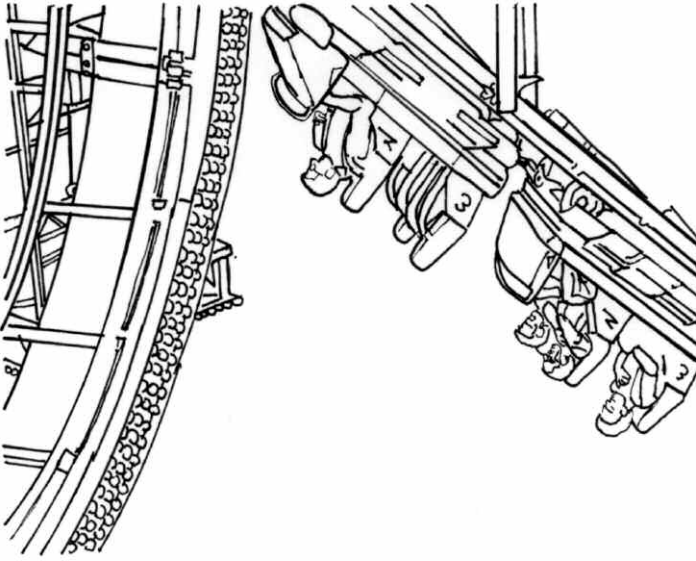

The car goes up.

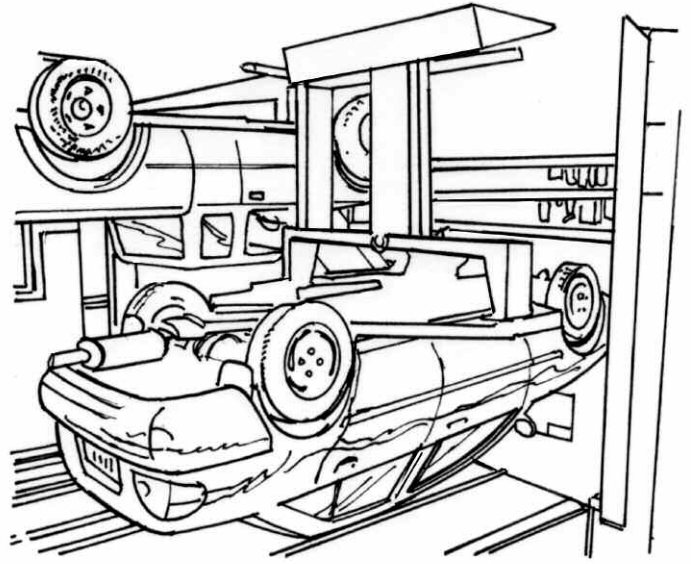

A

© 2006 Scholastic Canada Ltd. This page may be reproduced for classroom use by the purchasing school.

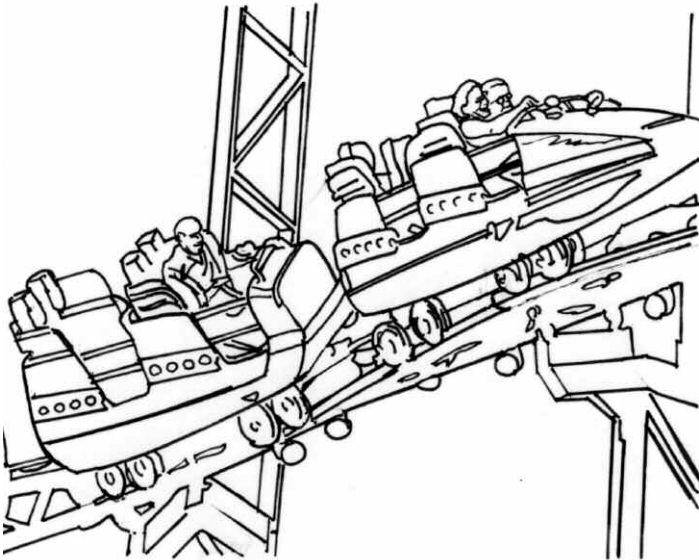

The roller coaster goes up.

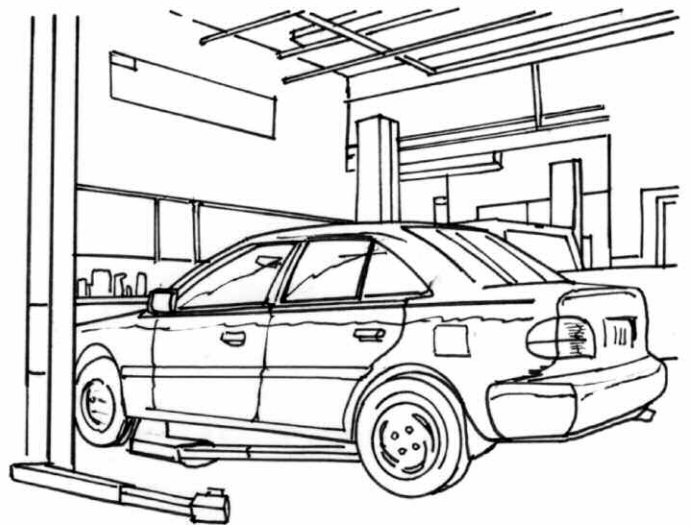

The car comes down.

The boy comes down.



The boy goes up.

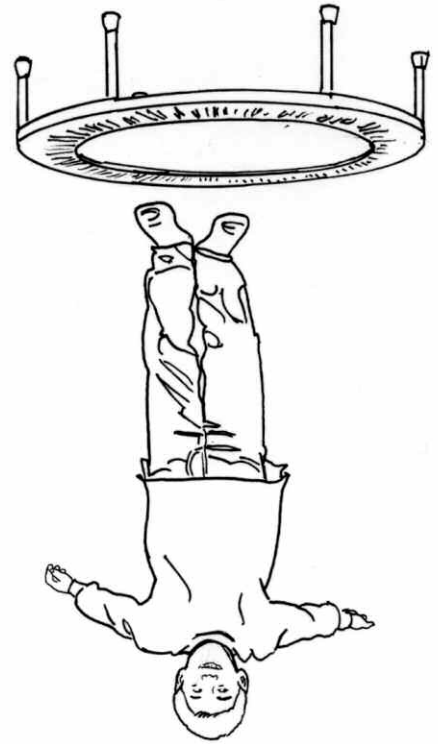

© 2006 Scholastic Canada Ltd. This page may be reproduced for classroom use by the purchasing school.

B

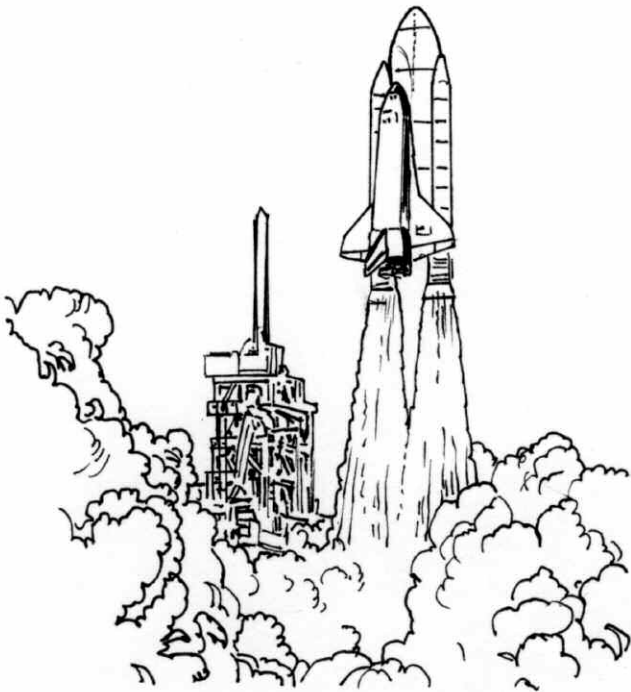

The space shuttle goes up.

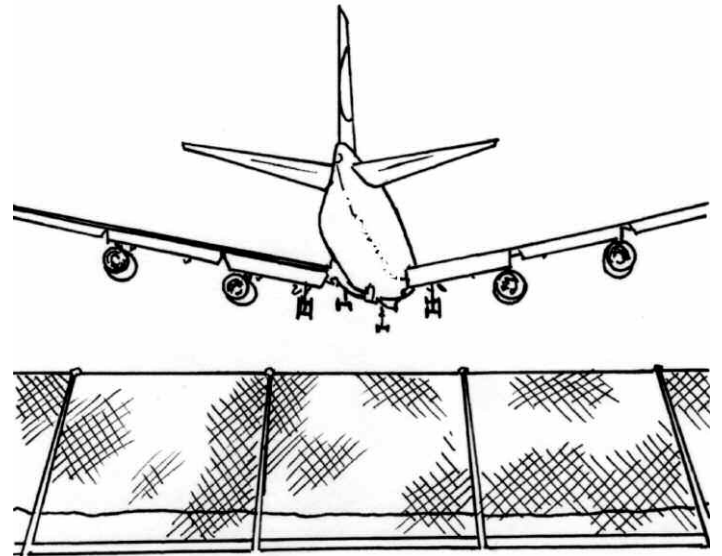

The plane comes down.

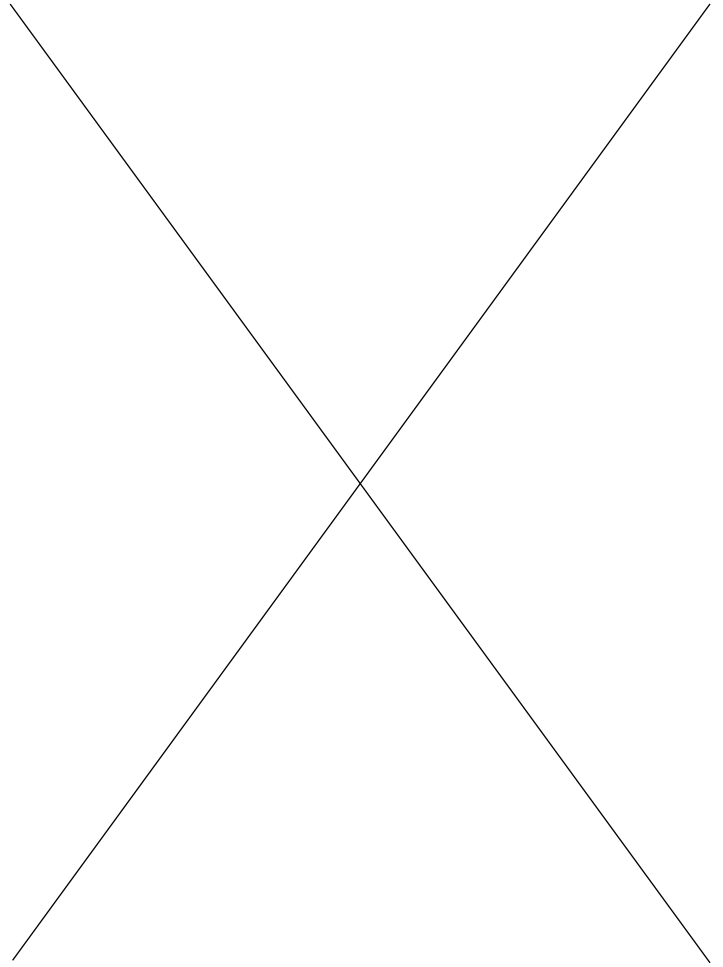
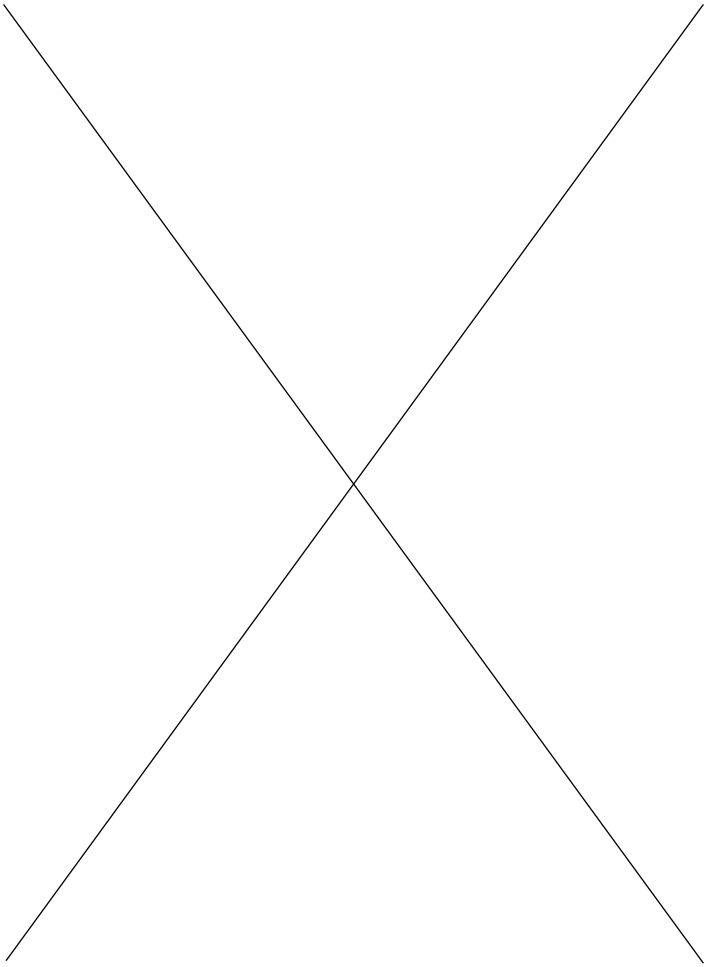

C

© 2006 Scholastic Canada Ltd. This page may be reproduced for classroom use by the purchasing school.

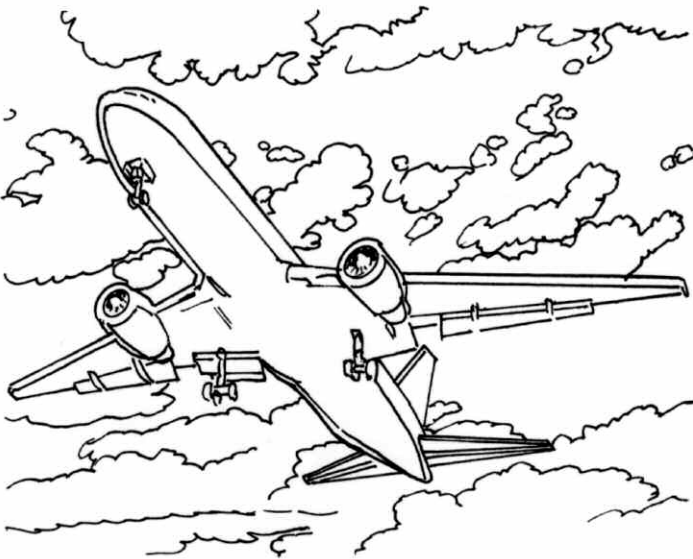

The plane goes up.

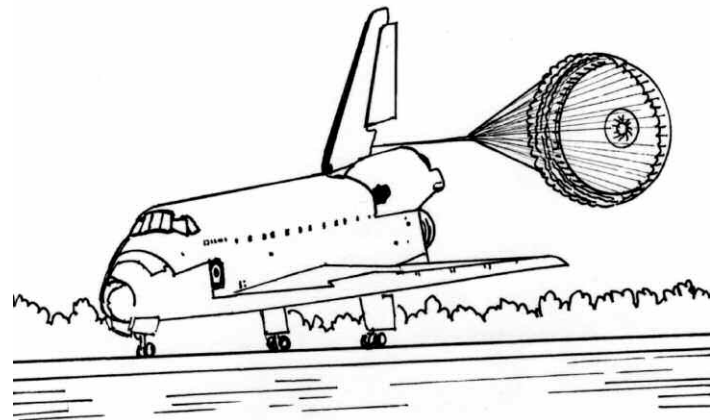

The space shuttle comes down.

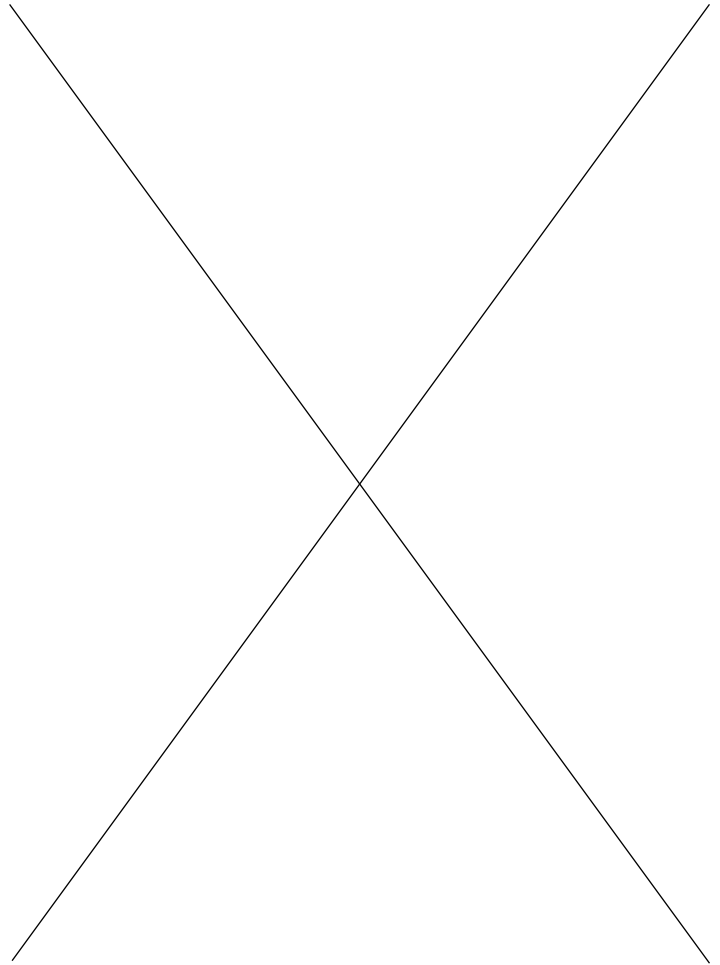
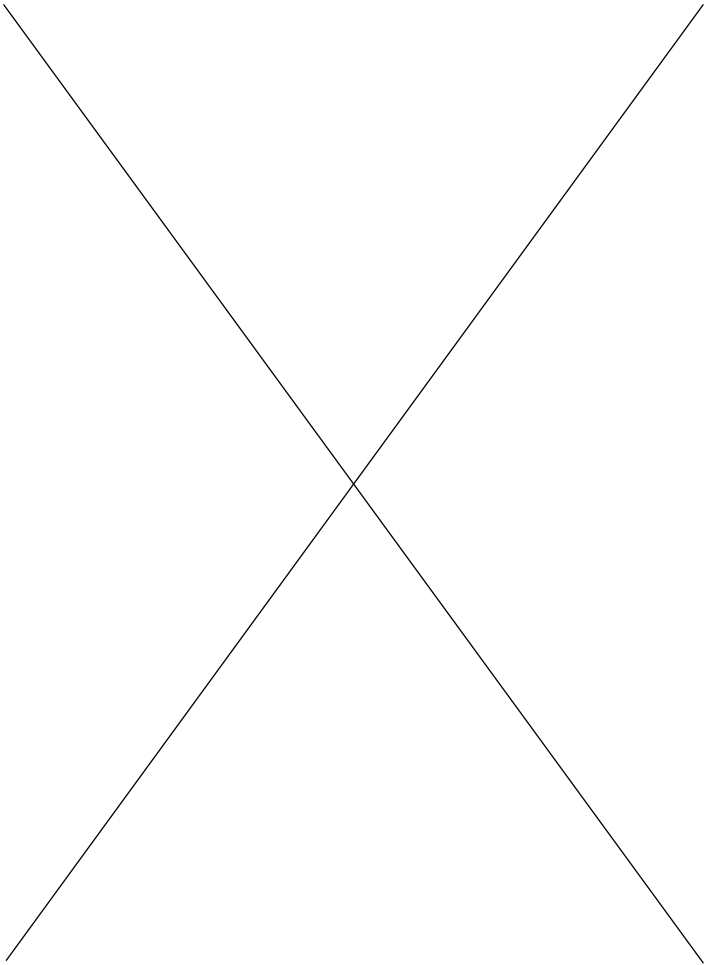

© 2006 Scholastic Canada Ltd. This page may be reproduced for classroom use by the purchasing school.

D 



Up and Down

by Nicholas Kounkar

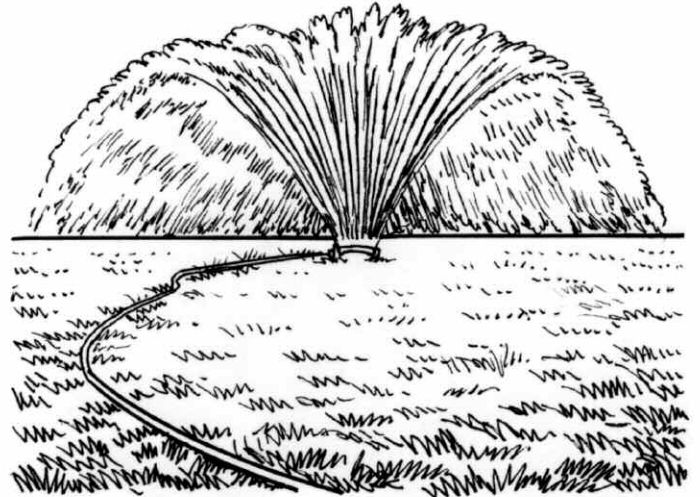
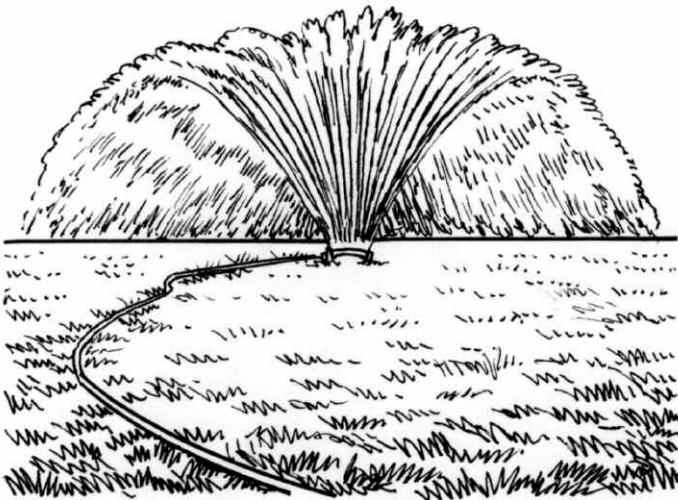

12 The water goes up,
and the water comes down.

© 2006 Scholastic Canada Ltd.

